

# Versa Pro Wired Thermostat

## Installation & Owner's Manual

**MODEL:  
16117100003415**

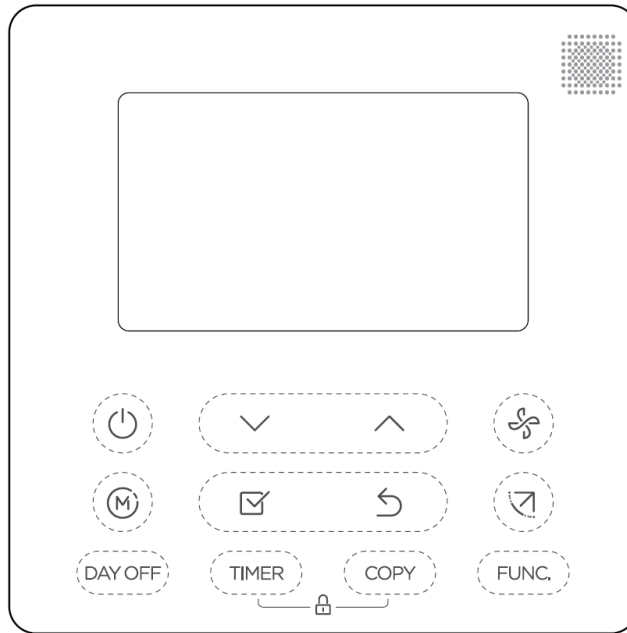

Read this manual carefully before installation and keep it where the operator can easily find it for future reference.

Due to updates and constantly improving performance, the information and instructions within this manual are subject to change without notice.

Version Date: 04/30/2024  
Please visit [www.mrcool.com/documentation](http://www.mrcool.com/documentation)  
to ensure you have the latest version of this manual.



## CONTENTS

<b>1</b> SAFETY PRECAUTIONS .....	2
<b>2</b> PACKING LIST.....	3
<b>3</b> PRODUCT OVERVIEW .....	4
3.1 Dimensions.....	4
3.2 Technical Requirements .....	4
3.3 Specifications .....	4
3.4 Features & Functions.....	4
3.5 LCD Display.....	5
3.6 Controller Buttons .....	6
<b>4</b> INSTALLATION .....	7
<b>5</b> OPERATION .....	11
5.1 Set Day & Time .....	11
5.2 Start/Stop Operation .....	11
5.3 8° Heating Function .....	11
5.4 Set Operation Mode .....	12
5.5 Set Room Temperature.....	12
5.6 Set Fan Speed .....	12
5.7 Set Keypad Tone .....	13
5.8 Set Child Lock Function.....	13
5.9 Set Turbo Function .....	13
5.10 Set PTC Function .....	13
5.11 Set Follow Me Function .....	13
5.12 Intelligent Eye Display.....	14
5.13 Filter Reset Function .....	14
5.14 Humidity Setting Function.....	15
5.15 GEAR Function.....	15
5.16 Set Rotation & Backup Function .....	15
5.17 Set Timer Functions.....	16
5.18 Wireless Control Connection.....	24
<b>6</b> SETTINGS.....	24
<b>7</b> TROUBLESHOOTING .....	26

### IMPORTANT INSTALLATION INFORMATION!

- Read this manual carefully before installing and operating the wired thermostat. Retain this manual for future reference.
- This manual provides detailed descriptions of the precautions that you should be aware of during operation.
- In order to ensure accurate servicing and repair, read this manual carefully before performing maintenance.
- All of the illustrations in this manual are for explanatory purposes only. There may be slight differences between the illustration and the purchased thermostat.

## 1-Safety Precautions

### Read Before Using

Incorrect usage may cause serious damage or injury.



## WARNINGS FOR PRODUCT INSTALLATION

**INSTALLATION MUST BE PERFORMED BY AN AUTHORIZED DEALER OR SPECIALIST. DEFECTIVE INSTALLATION CAN CAUSE WATER LEAKAGE, ELECTRICAL SHOCK, OR FIRE.**

1. Follow all steps detailed in this manual.
2. Improper installation could lead to electric shock or fire.
3. Moving and re-installation must be performed by professionals. Failing to do so may lead to abnormal operation or fire.
4. Do not install the unit in a place that is vulnerable to flammable gas leakage. Leakage of flammable gas could lead to fire.
5. Do not install in a location with oil, vapor, or sulfured gas, as the unit can become deformed, leading to system malfunction.
6. Do not operate the thermostat with wet hands or let water enter the thermostat. Otherwise, electric shock could occur.
7. Ensure the wiring corresponds with the thermostat's current requirements. Failing to do so could cause electrical leakage and fire.
8. For wiring, use only the cables specified. Do not subject the terminal to external force. This could lead to the wire becoming damaged and result in fire.
9. Refer to the wiring diagram included in this manual to connect the wired controller to the indoor unit.
10. The wired controller works in a low voltage loop circuit. **DO NOT** directly connect the cable to high voltage (115V, 220V). Keep a clearance between the flex or rigid conduit at 12-20 inches (300-500mm) or above.
11. The shielded cable of the wired controller must be firmly grounded.
12. **DO NOT** use an insulation resistance tester.



## BATTERY WARNINGS-KEEP OUT OF REACH OF CHILDREN



### **INGESTION HAZARD: Contains button cell or coin battery.**

- If the battery compartment does not close securely, stop using the product and keep it away from children.
- If batteries may have been swallowed or placed inside any part of the body, seek immediate medical attention.
- Swallowing can lead to chemical burns, perforation of soft tissue, and death. Severe burns can occur within 2 hours of ingestion. Seek medical attention immediately.
- Remove and immediately recycle or dispose of used batteries according to local regulations and keep away from children. **DO NOT** dispose of batteries in household trash or incinerate. Even used batteries can cause severe injury or death.
- Non-rechargeable batteries are not to be recharged.
- Call a local poison control center for treatment information.
- Do not force discharge, recharge, disassemble, heat above the manufacturer's specified temperature rating, or incinerate. Doing so may result in chemical burn injuries due to venting, leakage, or explosion.
- Ensure the batteries are installed correctly according to polarity (+ and -).
- Do not mix old and new batteries or different brands of types of batteries, such as alkaline, carbon-zinc, or rechargeable batteries.
- Remove and immediately recycle or dispose of batteries from equipment not used for an extended period of time according to local regulations.
- Battery type: CR2032
- Battery Power Supply: 3.0V

# 2 PACKING LIST

## 2-Packing List

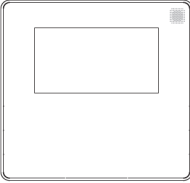
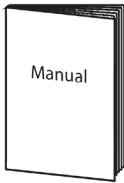
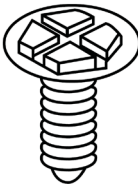
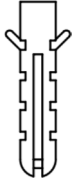
The listing below shows the accessories and parts (these may vary depending on purchase & options). Use all of the installation parts and accessories to install the system. Improper installation may result in water leakage, electrical shock, fire, and/or equipment failure.

PART	LOOKS LIKE	QUANTITY
Wired Controller		1
Installation & Owner's Manual		1
Screws		6 (Three M3.9*25-Wall Mount) (Two M4x25-Switch Box Mount) (One M4x8-Connective Wire Group Mount)
Wall Plugs		3 (For wall-mounting)
Plastic Screw Bars		2 (For attaching to switch box)
Battery		1

### To Be Prepared by Installer:

#### 1. Switch Box

3.2 x 3.2 inches (82 x 82 mm)

#### 2. Wiring Tube

Insulating Sleeve and Tightening Screw

## 3.1 Dimensions

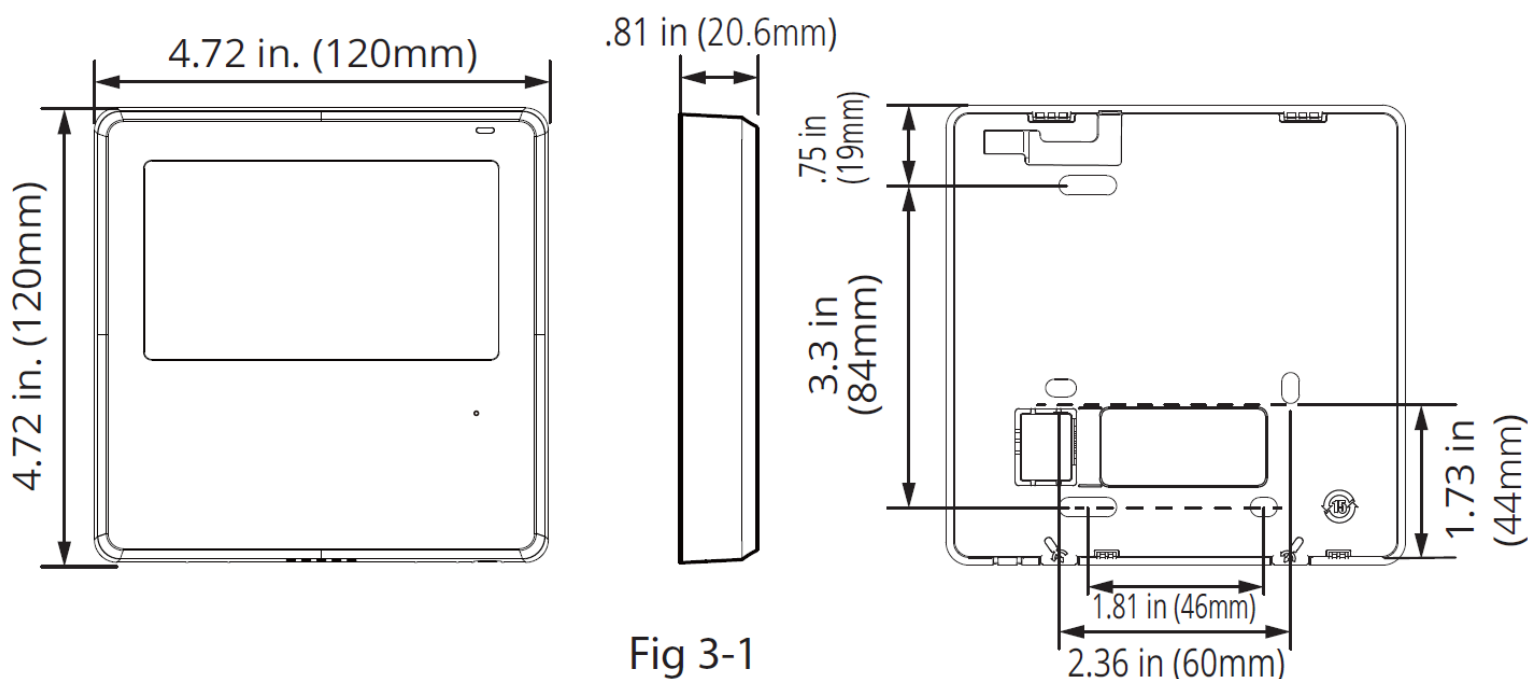

## 3.2 Technical Requirements

EMC and EMI comply with CE certification requirements.

## 3.3 Specifications

<b>Input Voltage</b>	<b>DC 12V</b>
<b>Ambient Temperature</b>	<b>32~110°F (0~43°C)</b>
<b>Ambient Humidity</b>	<b>RH40%~RH90%</b>

<b>Wiring Type</b>	<b>Size</b>	<b>Total Length</b>
<b>Shielded Cable</b>	<b>0.5mm<sup>2</sup></b>	<b>&lt;66 ft (20m)</b>
	<b>0.75-1.25mm<sup>2</sup></b>	<b>&lt;164 ft (50m)</b>

**Note:** A connective wire of 19.68 feet (6 meters) is recommended.

## 3.4 Features & Functions

<b>Features:</b>	<b>Functions:</b>	
<ul style="list-style-type: none"> <li>LCD Display</li> <li>Error Code Display</li> <li>4-Way Wire Layout Design</li> <li>Room Temperature Display</li> <li>Weekly Timer</li> </ul>	<ul style="list-style-type: none"> <li>Modes: Auto, Cool, Dry, Heat, Fan</li> <li>Fan Speeds: Auto/Low/Med/High speed</li> <li>Timer ON/OFF</li> <li>Temperature Setting</li> <li>Follow Me</li> <li>Turbo</li> <li>24-Hour System</li> <li>12-Hour System</li> <li>Sleep</li> </ul>	<ul style="list-style-type: none"> <li>8 Degree Heating Function</li> <li>Auto Restart</li> <li>Automatic Airflow Test</li> <li>Rotation &amp; Backup</li> <li>Dual Control</li> <li>Group Control</li> <li>Child Lock</li> <li>Clock</li> </ul>

# 3 PRODUCT OVERVIEW

## 3.5 LCD Display

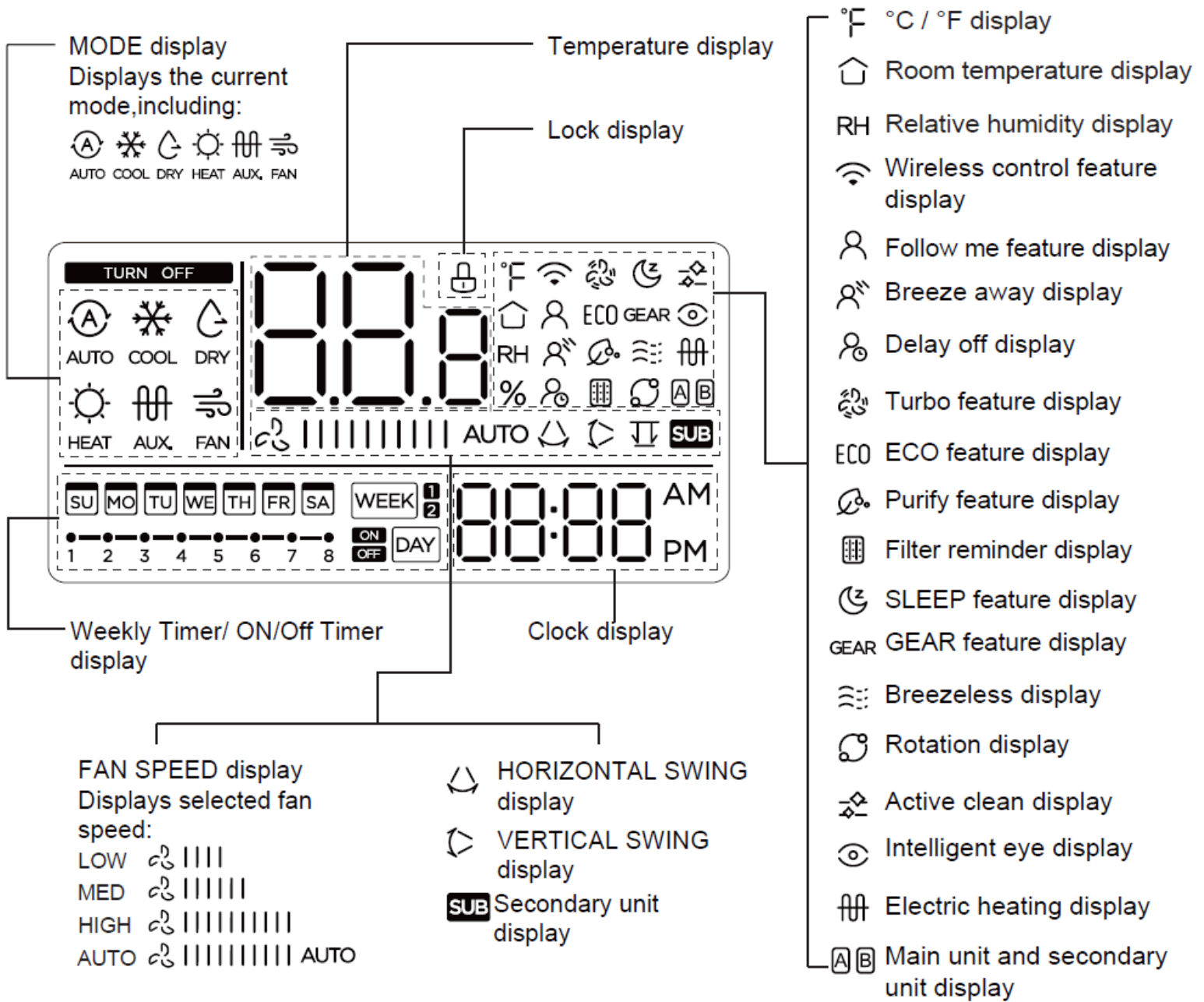

## 3.6 Controller Buttons

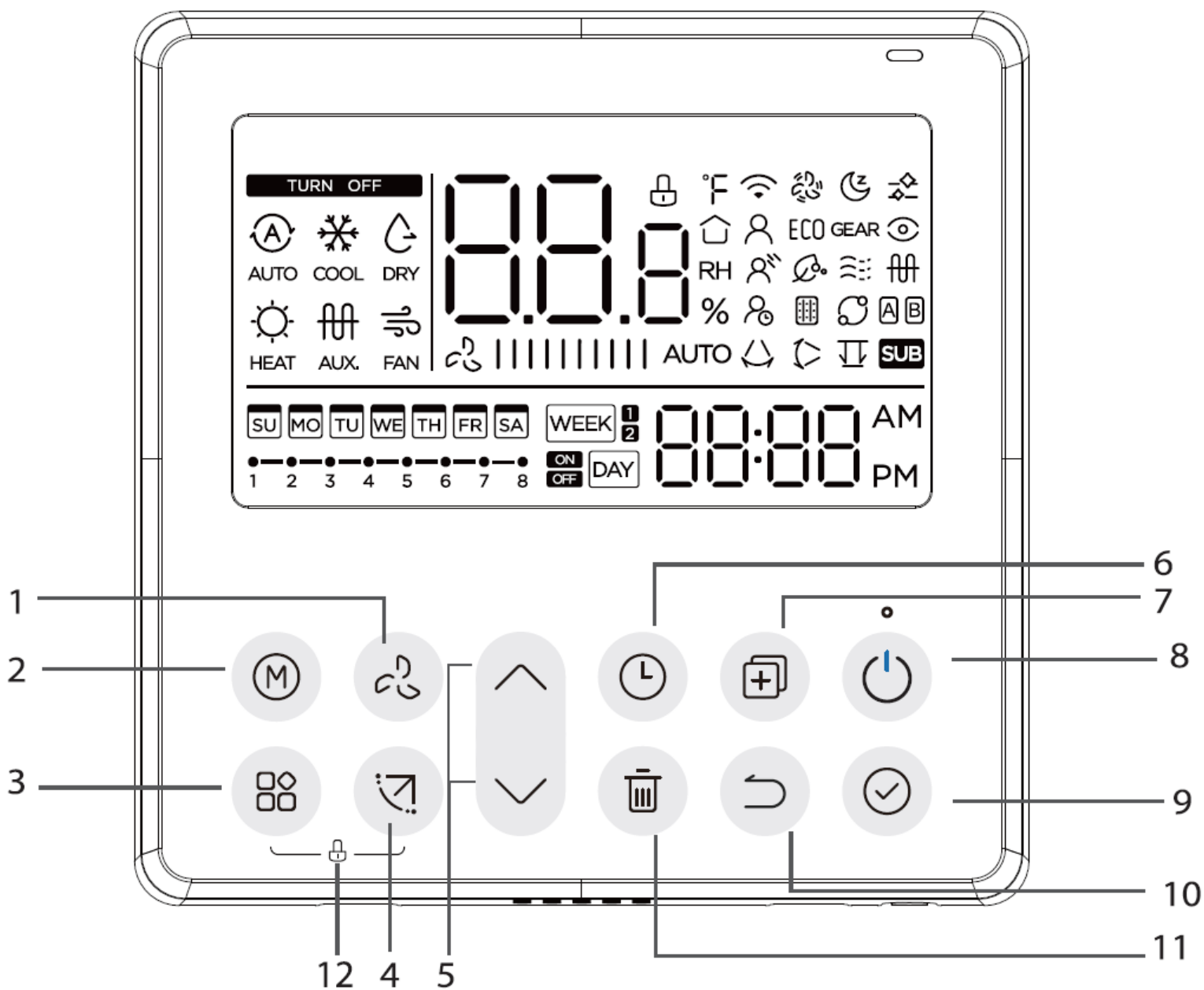

- 1. FAN SPEED button
- 2. MODE button
- 3. FUNC. button
- 4. SWING button
- 5. ADJUST button
- 6. TIMER button

- 7. COPY button
- 8. POWER button
- 9. CONFIRM button
- 10. BACK button
- 11. DAY OFF/DELAY button
- 12. CHILD LOCK button

# 4 INSTALLATION

## 4-Unit Installation

### Step 1: Remove the upper section of unit

Insert a flat head screwdriver into the slots located at the bottom of the wired controller (2 places). Remove the front cover. (See fig. 4-1)

**NOTE: Do not pry up and down, only rotate the screwdriver.**

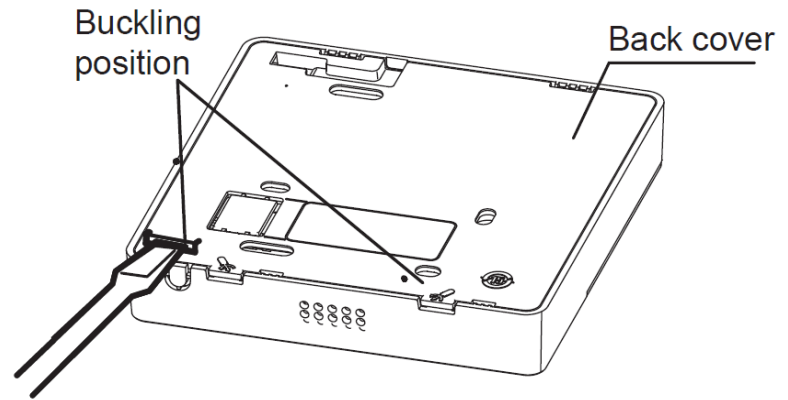

### NOTE

The Printed Circuit Board (PCB) is mounted in the upper part of the wired controller. Use care not to damage the board with the flat head screwdriver.

### Step 2: Attach Back Plate

For exposed mounting, fasten the back plate to the wall with 3 ST3.9\*24 screws and plugs. (See fig. 4-2)

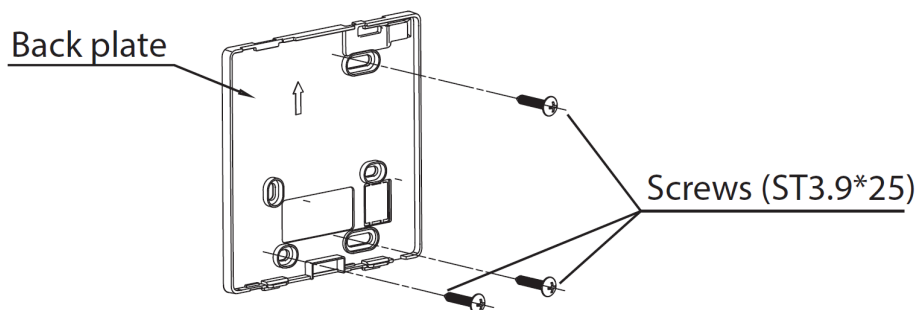

Fig 4-2

Use 2 M4X25 screws to install the back cover of the 86 switch box, and use 1 ST3.9\*25 screw to attach to the wall.

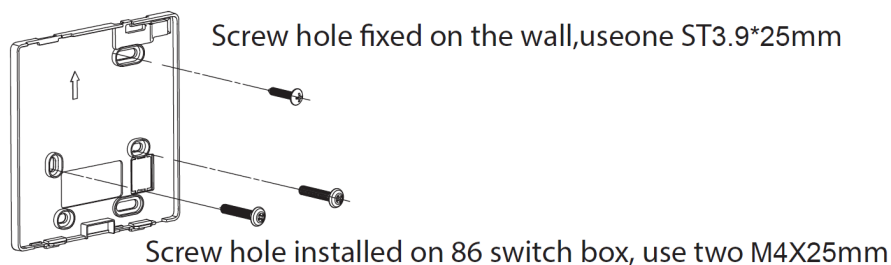

Fig 4-3

### NOTE

Attach to a flat surface. Be careful not to distort the back plate of the wire controller by over-tightening the mounting screws.



## Step 3: Battery Installation

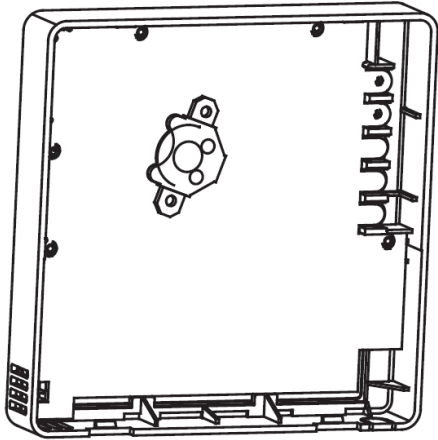

Fig 4-4

### NOTE

Put on a flat surface. Be careful not to distort the back plate of the controller by over-tightening the mounting screws.

- Put the battery into the battery compartment, ensuring the positive side of the battery is in accordance with the positive side of the compartment.
- Set the correct time during the first operation.
- Batteries in the wired controller can keep time after a power failure. When power is restored, the time display should still remain correct. If it is incorrect, replace the battery and reset the time.

## Step 4: Indoor Unit Wiring

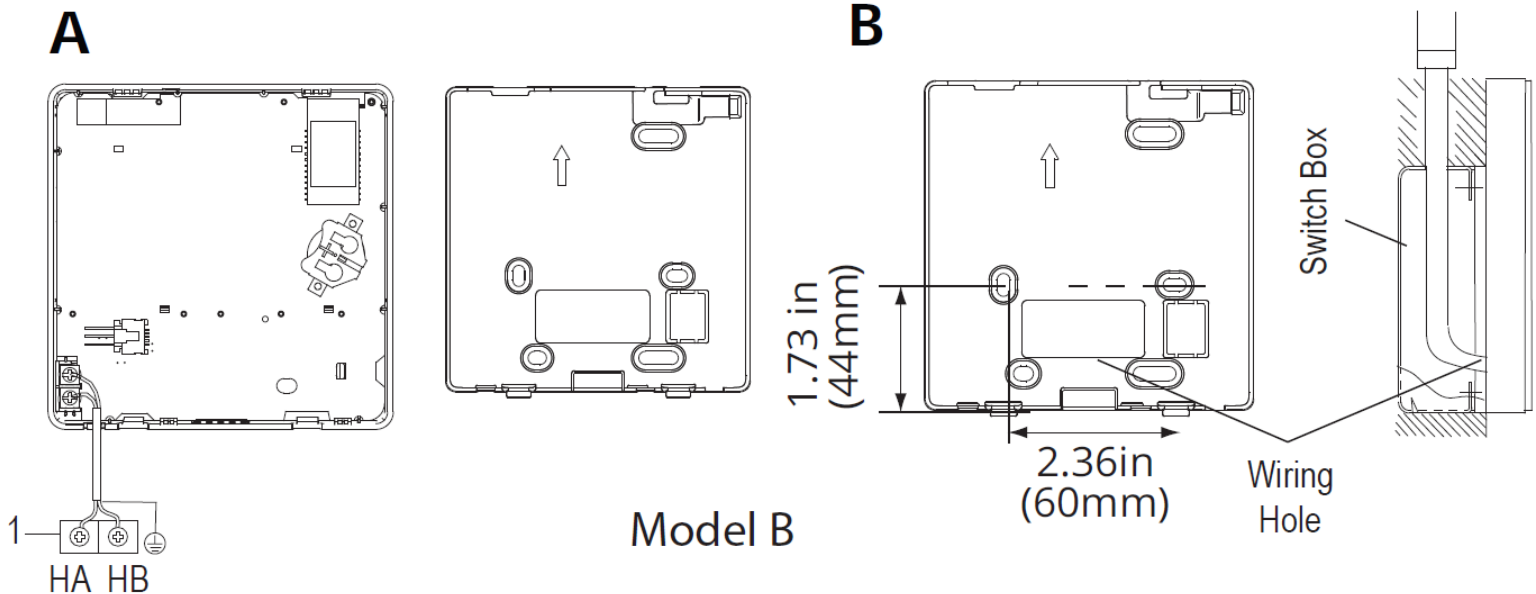

Fig 4-5

- Using pliers or a similar tool, notch the section for the wiring to pass through.
- Connect the terminals on the remote controller (HA, HB), and the terminals of the indoor unit (HA, HB). (HA and HB do not have polarity. See Fig. 4-5.)

### NOTE

- **DO NOT** allow water to enter the wired controller. Use the trap and putty to seal the wires.
- The connecting wires must be fixed and cannot be pulled.

# 4 INSTALLATION

For some units, the wired controller connects to the unit HA and HB ports through the HA and HB ports. There is no polarity between HA and HB. See Figure 4-6.

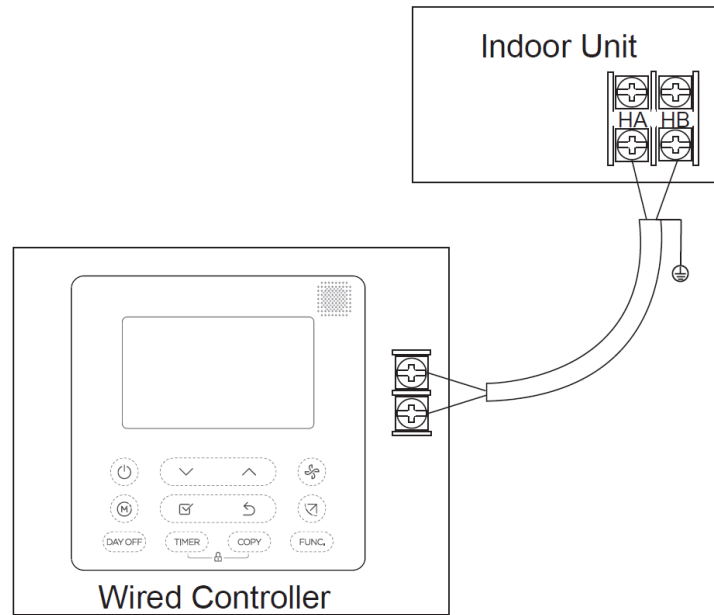

Fig.4-6

The main/secondary wired controller can be used to enable two wired controllers to control one unit. The wired controllers connect to the unit's HA and HB ports through the HA and HB port on the controller. There is no polarity between HA and HB. See Fig. 4-7.

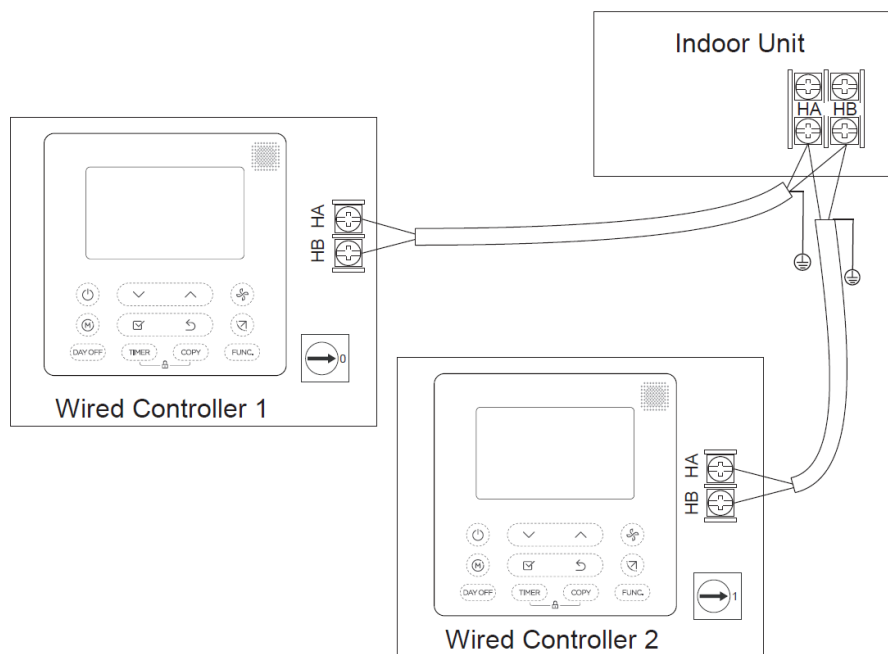

Fig.4-7

### NOTE

Wired controller with wireless function does not have this function.

For some units, one wired controller can support multiple units (a maximum of 16 units). In this case, the wired controller and unit need to be connected to the HA and HB ports at the same time. Please note: In group control, there will be no errors displayed on the wired controller.

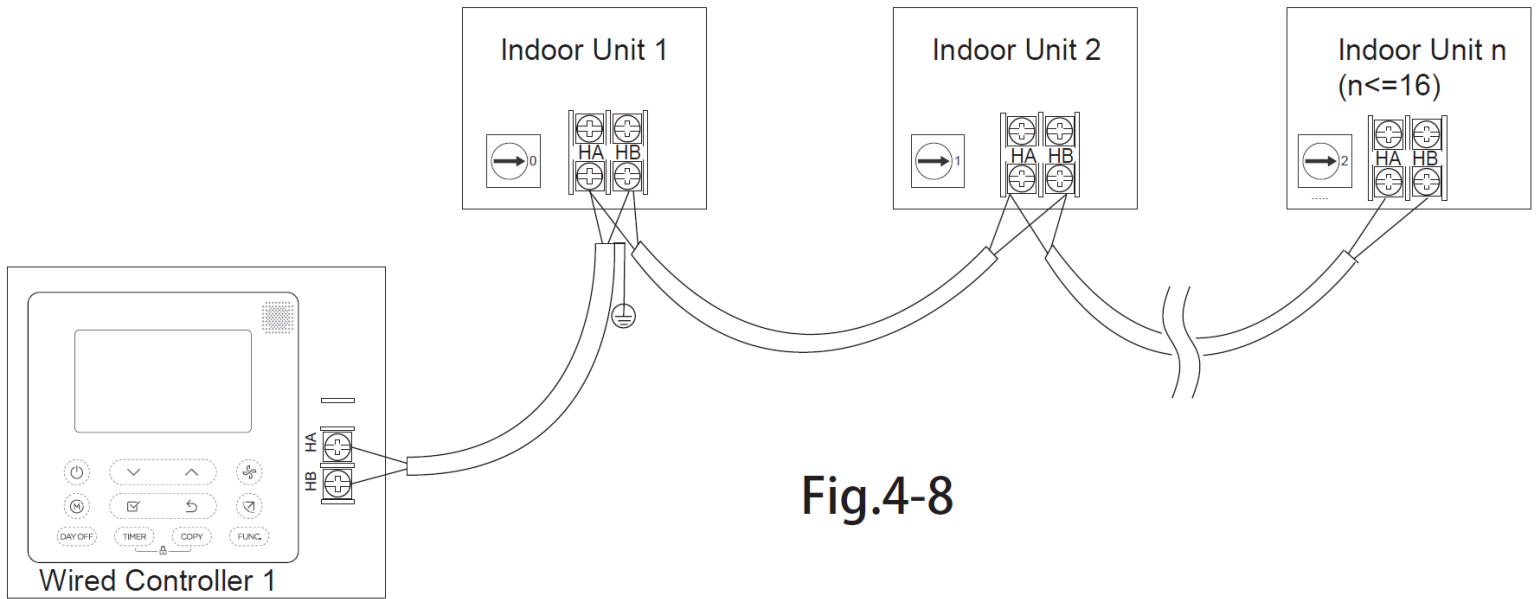

Fig.4-8

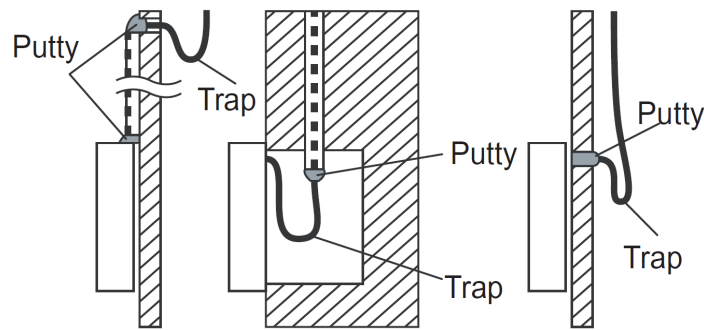

Fig 4-9

### Step 6: Reattach upper section of unit

Adjust the upper section, then attach. Avoid accidental clamping of the wiring when reattaching the front face of the controller. See Fig. 4-10.

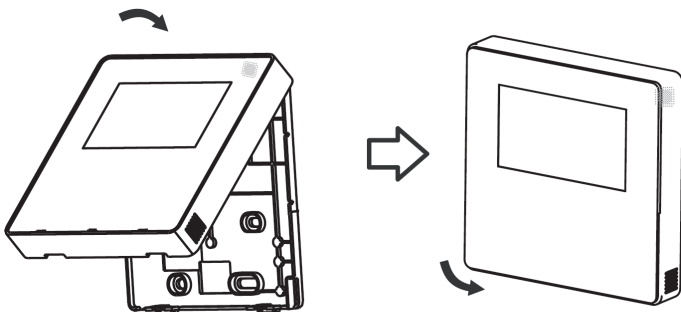

Fig 4-10

#### NOTE

The illustrations in this manual are for explanatory purposes only. Your actual controller design may vary from what is shown here.

# 5 OPERATION

## 5.1 Set Day & Time



**Step 1:** Press the Timer button for 2 seconds or longer. The timer display will flash.



**Step 2:** Press the " $\wedge$ " or " $\vee$ " button to set the date. The selected date will flash.



**Step 3:** To complete this process, press the Timer button or the Confirm button. If no button is pressed within 10 seconds, the process will automatically complete.



**Step 4:** Press the " $\wedge$ " or " $\vee$ " button to set the current time. Press repeatedly to adjust the current time in 1-minute increments. Press and hold to adjust the current time continuously.

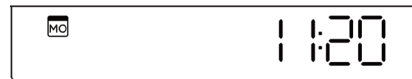

ex.Monday 11:20



**Step 5:** To complete this process, press the Timer button or Confirm button. If no button is pressed within 10 seconds, the process will complete automatically.



**Step 6:** Time Scale Selection-Pressing the Timer and Delete buttons for 2 seconds will alternate the clock time display between a 12-hour and 24-hour scale.

## 5.2 Start/Stop Operation



Press the power button to start or stop operation.

## 5.3 8° Heating Function



When the heating mode temperature is 50°F (10°C) / 60°F (16°C) / 62°F (20°C) / 68°F (20°C), press the down button twice within 1 second to turn on the 8° heating function. Press the Power, Mode, Adjust, Fan Speed, Timer, or Swing button to cancel the 8°F heating function.

### NOTE

For some models, the 8° heating function can only be set by remote control. It cannot be chosen via the wired controller.

## 5.4 Set Operation Mode



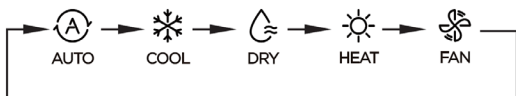

Press the Mode button to set the operation mode. (Heat function is invalid for a cooling-only type unit.)

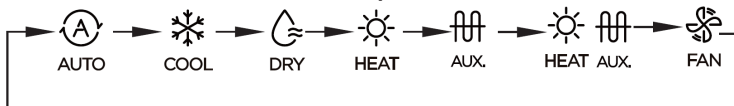

If the indoor unit has electric heating (emergency heating), press this button to select the operation mode:



- When the emergency (or electric) heating mode is selected, the  icon is displayed, and the fan speed is Auto. The Sleep, 8° Heating, Turbo, and Rotation functions are not available in emergency heating mode.
- When the heating and electric heating mode is selected, the  icons are displayed, and the Turbo and Rotation functions are disabled.

## 5.5 Set Room Temperature



Press the "∧" or "∨" button to set the room temperature.

### Indoor Setting Temperature Range:

✓ 50/60/62~86°F (10/16/17~30°C) or 68~82°F (20~28°C) according to the set temperature range of the unit. (Model Dependent)

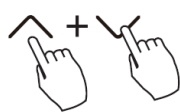

### °C and °F scale selection:

Pressing the "∧" or "∨" buttons for 3 seconds will alternate the temperature display between the °C and °F scale.

## 5.6 Set Fan Speed



Press the Fan speed button to set the fan speed. (This button is unavailable when in Auto or Dry mode.)

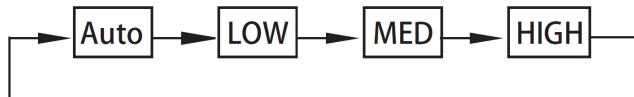

If stepless speed regulation is supported, press the fan speed key to cycle through:

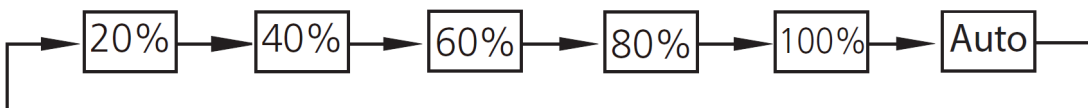

## 5.7 Set Keypad Tone



- Press the (M) and (Keypad Tone) buttons simultaneously for 3 seconds to turn the keypad tone on or off.

## Operation Functions:

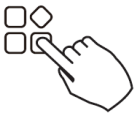

- Press the FUNC. button to scroll through operation functions as follows:

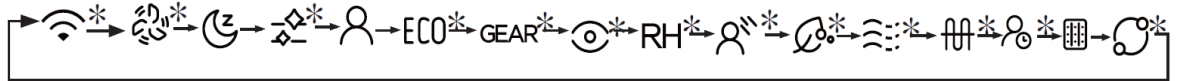

[\*]: Model dependent. If the indoor unit does not have this function, it will not be displayed.



The select function icon will flash. Press the Confirm button to confirm the setting.

## 5.8 Set Child Lock Function

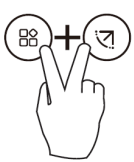

- Press the buttons (Keypad Lock) and (Keypad Lock) for 3 seconds to activate the child lock function and lock all buttons on the wired controller.
- You cannot press the button to operate and receive remote control signal when the child lock is activated.
- Press these two buttons again for 3 seconds to deactivate the child lock function.
- When the child lock function is activated, the (Keypad Lock) mark appears.

## 5.9 Set Turbo Function



Under cool or heat mode, press the FUNC button to activate the turbo function. Press the button again to deactivate the turbo function. When activated, the (Turbo) symbol is displayed.

## 5.10 Set PTC Function

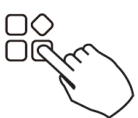

In heating operation, for the units with the electric heating feature, press this button to activate electric heating mode. When the PTC function is activated, the (PTC) symbol is displayed.

Note: The electric auxiliary heating function of the AHU model is switched by the MODE button, and the FUNC. button acts as a turbo function.

### 5.11 Set Follow Me Function



Press the FUNC. button to select whether the room temperature is detected at the indoor unit or the wired controller.

When the follow me function indicator appears, the room temperature is detected by the wired controller.

Press the button again to cancel the follow me function.

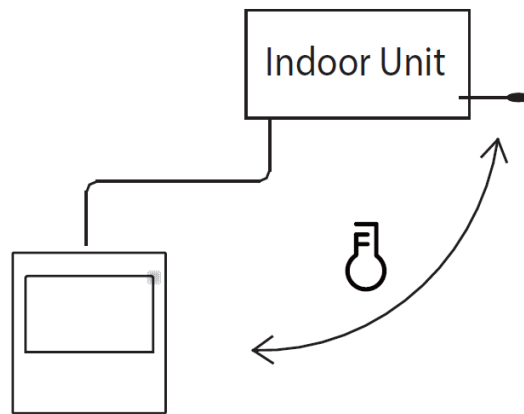

### 5.12 Intelligent Eye Display



1. This function is valid in any mode when the unit is powered on.
2. Press the function key to select the smart eye icon, then press the OK key to activate the smart eye function. The icon will light up. When the smart eye function is turned off, the icon will no longer be lit.
3. Activating shutdown, switch mode, self-cleaning, and 8° Heating functions will automatically cancel the smart eye function.

### 5.13 Filter Reset Function



The indoor unit automatically sends the wired controller the filter's usage time. When cleaning is needed, the filter cleaning prompt icon will light up. Press the function key to select the filter cleaning prompt icon, and press the OK key to reset the filter screen time. The filter cleaning reminder icon will no longer be lit.

## 5.14 Humidity Setting Function

- If the unit features dual control function of temperature and humidity, in dehumidification mode, press the function key to select the RH icon and press the confirm key to enter the humidity control mode. The RH icon will flash. Press the up and down keys to adjust the humidity. The setting range is OFF -> 35%~85%, adjusted with 5% humidity. After 5 seconds of inactivity, the unit will automatically exit the humidity adjustment state.
- After entering humidity control mode, press the up and down keys to adjust the set temperature. The set temperature will display for 5 seconds then restore the humidity display.
- After switching the mode, exit the humidity control mode.

## 5.15 GEAR Function

- If the unit features the GEAR function, in the boot cooling mode, press the function key to select the GEAR icon. Press the confirm key to enter the GEAR control mode, and the current GEAR status will be displayed.
- 50% -> 75% -> OFF can be switched using the up and down keys within 5 seconds. After 5 seconds, the set temperature will be displayed. Press the up and down keys to adjust the set temperature.
- To turn off, switch to mode or turn on the sleep, ECO, strong, or self-cleaning functions to cancel the GEAR function.

## 5.16 Set Rotation & Backup Function

When there are two units, press the FUNC button to select the rotating function, and press "Confirm" to turn on or off the rotating function.

**1.** Press the Confirm button to set the rotating time, then press the "V" or "Λ" button to set the time. The time setting range is 1~99h. The default time is 10 hours.

**2.** Set the high temperature. (If the ambient temperature is between 78.8~89.6°F (26~32°C), this function is invalid. If the ambient temperature is between 78.8~89.6° (26~32°C), or is greater than or equal to the set temperature, the two machines will run at 75.2°F (24°C) in cool mode at the same time.



3. Set the low temperature. (If the ambient temperature is between 41~59°F (5~15°C), this function is invalid. When the ambient temperature is between 41~59°F (5~15°C) or when the ambient temperature is lower than the set temperature, the two machines will run 75.2°F (24°C) at the same time in heating mode.

4. Set which machine will run first: select A or B.

5. After this function is turned on, it will automatically turn on another unit and turn off the current unit (as long as the unit is running at the setting hour). Press the Power button to switch to another one immediately. A or B icons flash to indicate the corresponding unit failure.

If running more than one unit, and one unit fails, the controller will automatically switch to the other connected unit.

## 5.17 Set Timer Functions



### Weekly Timer

Use this timer function to set operating times for each day of the week.



### On Timer

Use this timer function to start unit operation. The timer and unit operation will start after the set time has been reached.



### Off Timer

Use this timer function to stop the unit. This function will stop the unit after the set time has been reached.



### On and Off Timer

Use this timer function to both start and stop unit operation. The timer operates and the unit starts and stops when the set times have been reached.

### On or Off Timer:



1. Press the Timer button to select the Day On or Day Off icon.



2. Press the Confirm button and the Timer display will flash.

# 5 OPERATION

3. Press the "V" or "^" button to set the time. After the time is set, the timer will start or stop automatically.

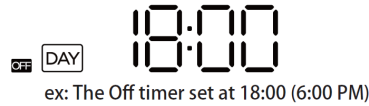

4. Press the Confirm button again to confirm the settings.

## On and Off Timer:

1. Press the Timer button to select Day On/Off icon.

2. Press the Confirm button and the Clock display will flash.

3. Press the "V" or "^" button to set the time of the On timer, and press the Confirm button to confirm the setting.

4. Press the "V" or "^" button to set the time of the Off timer.

5. Press the Confirm button to confirm the settings.

### NOTE

The secondary wired controller cannot set the timer.

## Weekly Timer:

1. Press the Timer button to select the **WEEK** symbol, then press the Confirm button to confirm the selection.

2. Press the "V" or "^" button to select the day of the week, then press the Confirm button to confirm the selection.

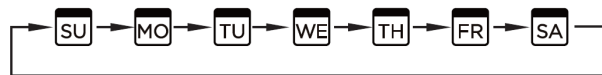

3. Press the "V" or "^" button to set the time for the On timer, then press the Confirm button to confirm the setting.

Up to 4 timer settings can be saved for each day of the week to best accommodate individual needs.





4. Press the "V" or "^" button to set the time for the Off timer, then press the Confirm button to confirm the setting.



ex: Tuesday time scale 1

5. Different timer settings can be set by repeating steps 3 & 4.

6. Additional days in one week can be set by repeating 2-5.

### NOTE

When in the weekly timer setup process, return to the previous step by pressing the Back button. The time can be deleted by pressing the Day Off button. The current setting will be restored and the weekly timer setting will be withdrawn automatically when there is no operation for 30 seconds.

### Weekly Timer Activation:



Press the Timer button while WEEK1 is displayed.

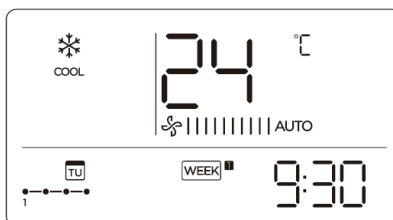

### Weekly Timer Deactivation:



Press the Timer button to while WEEK1 is displayed and it will disappear.

### Power Off During Weekly Timer:



1. When the power button is pressed once quickly, the unit will turn off temporarily. The unit will turn on automatically at the set time of the timer.

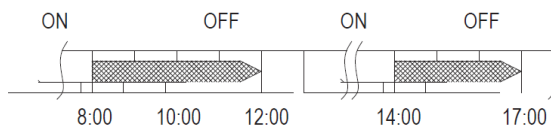

**Example:** If the power button is pressed once quickly at 10:00, the unit will turn on at 14:00.

2. When you press the power button for 2 seconds, the unit will turn off completely, and cancel the timer.

## Weekly Timer Day Off Setting:



1. When in the weekly timer function, press the Confirm button.



2. Press the "V" or "^" button to select the day of the week.



3. Press the Day Off button to select the day off.

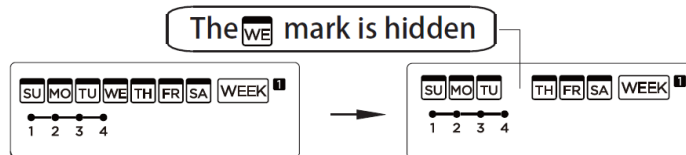

ex: The DAY OFF is set for Wednesday

4. The day off can be set for other days by repeating steps 2 and 3.



5. Press the BACK button to go back to the weekly timer.

**To Cancel:** Follow the same procedures as those used for setup.

### NOTE

The day off setting is canceled automatically after the set day has passed.

## Weekly Timer Delay Function:



When in the weekly timer function, press the FUNC. button, select the delay function, and press the Confirm button. "0h", "1h", and "2h" will be displayed. Wait 3 seconds to confirm. When the delay function is activated, the  icon is displayed. The delay function can only be enabled in Weekly Timer 1 and Weekly Timer 2.

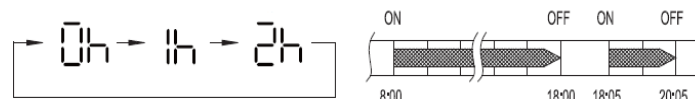

Example: If "2h" is selected at 18:05, the unit will delay turning off until 20:05.

## Weekly Timer Day Setting Duplication

A timer setting made once on one day can be copied to another day of the week. All of the timer settings of the selected day of the week will be copied.



1. When in the weekly timer function, press the Confirm button.



2. Press the "V" or "^" button to select the day of the week to copy from.



3. Press the Copy button, and the letters "Cy" will be displayed.



4. Press the "V" or "^" button to select the day of the week to copy to.



5. Press the Copy button to confirm.

The **WE** mark flashes quickly

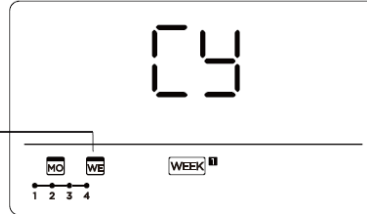

ex: Copy the setting of Monday to Wednesday

6. Repeat steps 4 & 5 to copy other days.



7. Press the Confirm button to confirm the settings.



8. Press the Back button to return back to the weekly timer function.

## 2nd Weekly Timer:



1. Press the Timer button to select the Week2 icon and press Confirm.



2. Press the "V" or "^" button to select the day of the week, then press the Confirm button to confirm the selection.



3. Press the "V" or "^" button to set the time. The set time, mode, temperature, and fan speed will be displayed. Press the Confirm button to confirm the setting.

**IMPORTANT:** Up to 8 scheduled events can be set on one day. Various events can be scheduled in either MODE, TEMPERATURE, and FAN speeds.

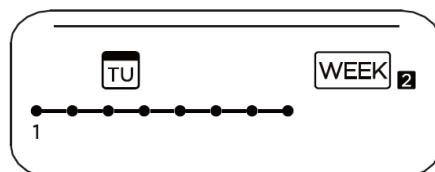

ex. Tuesday time scale 1

## 2nd Weekly Timer-Time Setting:



4. Press the "V" or "^" button to select the day of the week, then press the Confirm button to confirm the selection.

## 2nd Weekly Timer-Operation Mode Setting:



5. Press the "V" or "^" button to set the operation mode, then press Confirm.

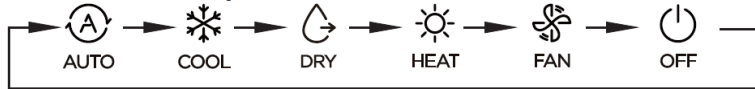

## 2nd Weekly Timer-Room Temperature Setting:



6. Press the "V" or "^" button to set the room temperature, then press Confirm.

NOTE: This setting is unavailable in the Fan or Off modes.

## 2nd Weekly Timer-Fan Speed Setting:



7. Press the "V" or "^" button to set the fan speed, then press Confirm.

NOTE: This setting is unavailable in the Auto, Dry, or Off modes.

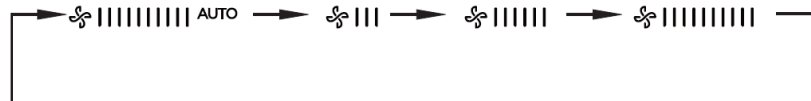

8. Different scheduled events can be set by repeating steps 3 through 7.

9. Additional days, in a one-week period, can be set by repeating steps 3 through 8.

### NOTE

The weekly timer setting can be returned to the previous step by pressing the Back button. The current setting is restored. The controller will not save the weekly timer settings if there is no operation within 30 seconds.

## 2nd Weekly Timer-Activation:



Press the Timer button to select WEEK2, and the timer starts automatically.

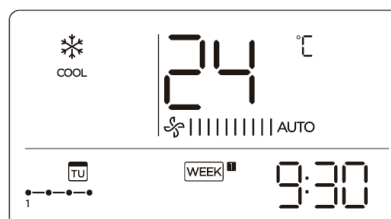

## 2nd Weekly Timer-Cancellation:



Press the Power button for 2 seconds to cancel the timer mode.



The timer mode can also be canceled by changing the timer mode using the Timer button.

## 2nd Weekly Timer Day Off Setting:



1. After setting the weekly timer, press Confirm.



2. Press the "V" or "^" button to select the day of the week.



3. Press the Day Off button to select the day off.

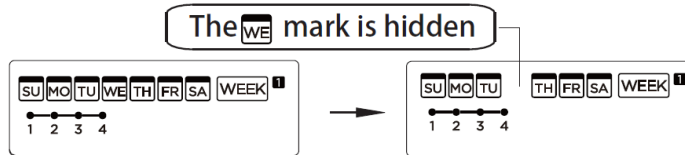

ex: The DAY OFF is set for Wednesday

4. The day off can be set for other days by repeating steps 2 and 3.



5. Press the Back button to go back to the weekly timer.

**To Cancel:** Follow the same procedures as those used for setup.

### NOTE

The day off setting is canceled automatically after the set day has passed.

## 2nd Weekly Timer Day Setting Duplication:

A scheduled event, made once, can be copied to another day of the week. The scheduled events from the selected day of the week will be copied.



1. When in the weekly timer function, press the Confirm button.



2. Press the "V" or "^" button to select the day of the week to copy from.



3. Press the Copy button, and the letters "CY" will be displayed.



4. Press the "V" or "^" button to select the day of the week to copy to.

# 5 OPERATION



5. Press the Copy button to confirm.

The **WE** mark flashes quickly

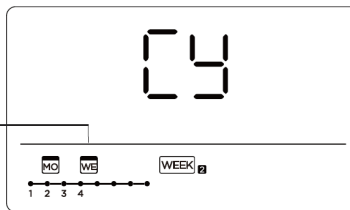

ex. Copy the setting of Monday to Wednesday

6. Repeat steps 4 & 5 to copy other days.



7. Press the Confirm button to confirm the settings.



8. Press the Back button to return back to the weekly timer function.

## 2nd Weekly Timer Time Deletion:



1. While in the weekly timer setting, press Confirm.



2. Press the "V" or "^" button to select the day of the week, then press the Confirm button.



3. Press the "V" or "^" button to select the time to be deleted. The set time, mode, temperature, and fan speed will be displayed. Press the DEL (Day Off) button to delete.

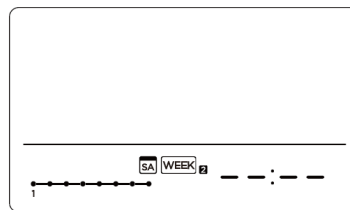
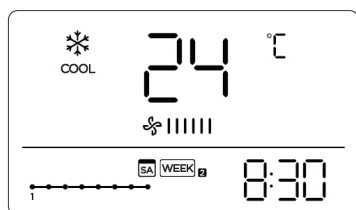

ex. Delete the time scale 1 in Saturday



## Query Function of Temperature:



1. Press the Copy button for 3 seconds. P:00 will be displayed if connected to a single indoor unit. If connected to multiple indoor units, press "V" or "∧" to display P:01, P:02, etc., then press Confirm to enter the query indoor unit Tn (T1~T4) temperature and fan fault (CF). Press "V" or "∧" to select.



2. If no operation is detected for 15 seconds or the Back button is pressed, the system will exit the query temperature function.

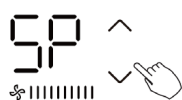

3. When the unit is off, in the query function of temperature, press "V" or "∧" to select SP, and press Confirm to adjust the static pressure value.

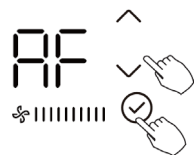

4. When the unit is off, in the query function of temperature, press "V" or "∧" to select AF, and press Confirm to enter test mode. Press "Back", "On/Off", or "Confirm" to exit test mode. In AF mode, the test completes after 3~6 minutes and automatically exits. If the test is in process, press "Back", "On/Off", or "Confirm" to interrupt the test and exit.

## Follow Me Function Temperature Compensation:

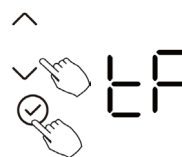

When the unit is off, in the query function of temperature, press "V" or "∧" to select tF. (tF = compensation temperature) The compensation temperature range is 23°F~41°F (-5°C~5°C). Press Confirm to enter setting state, press "V" or "∧" to select the temperature, then press Confirm to complete.



When the unit is off, in the query function of temperature, press "V" or "∧" to select type. Press Confirm to enter setting state, press "V" or "∧" to select the type, then press Confirm to complete.

CH:   
 AUTO COOL DRY HEAT FAN

HH:   
 HEAT FAN

CC:   
 COOL DRY FAN

NA:   
 COOL DRY HEAT FAN



## Highest & Lowest Temperature Value Setting:



When the unit is off, in the query function of temperature, press "V" or "Λ" to select tHI or tLO. Press Confirm to enter setting state, press "V" or "Λ" to select the temperature, then press Confirm to complete.



- The highest setting temperature range: 77°F~86°F (25°C~30°C)
- The lowest setting temperature range: 62.6°F~75.2°F (17°C~24°C)
- tHI = Highest Value Setting Function
- tLO = Minimum Value Setting Function

## Remote Control Function Selection:



When the unit is off, in the query function of temperature, press "V" or "Λ" to select rEC. On or Off will be displayed in the temperature areas to indicate whether it is valid or invalid. When the selection is invalid, the controller does not process any remote control signals. Press Confirm to enter setting state, press "V" or "Λ" to select the temperature, then press Confirm to complete.

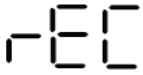

## Two-Line Controller Address Selection:



When the unit is off, in the query function of temperature, press "V" or "Λ" to select Adr. The temperature zone will display "--" or "A, B". (-- refers to the code setting of the controller) Press Confirm to enter setting state, press "V" or "Λ" to select the temperature, then press Confirm to complete.



-- : The code setting  of the controlled shall prevail.

Adr: The controller address setting

## Restore Factory Settings:



When the unit is off, in the query function of temperature, press "V" or "Λ" to select INIt. The temperature zone will display "--". Press Confirm to enter setting state, press "V" or "Λ" to select ON, then press Confirm to complete.



INIt: Restore Factory Settings

After the controller resumes the factory parameter setting, the following occurs:

- The rotating parameter setting is restored to 10 hours (the highest and lowest temperatures are not set).
- The compensation of body temperature is uncompensated.
- Cool and Heat/Single Cool mode is restored to Cool and Heat mode.
- Restore the temperature range to the factory setting.
- The remote receiving function is restored.
- The address of the two-control first-line controller is restored to the code switch.

## 7.1 Fault Alarms

If the system does not operate properly, review the previously mentioned cases for possible malfunction causes or investigate the system's fault codes according to the following procedures:

No.	Malfunction & Protection	Digital Display
1	Error of communication between wire controller and indoor unit	EH63

If the error displayed on the wired controller is different from that on the unit, check the unit's installation and user manual, the unit's service manual, or contact our technical support team at (270) 366-0457 for further assistance.

### Supplier's Declaration of Conformity Per FCC Part 2 Section 2.1077

**Unique Identifier:** Model-16117100003415

**Responsible Party - U.S. Contact Information**

**Company name:** MRCOOL®

**Street Address:** 48 Remington Way

**City, State:** Hickory, Kentucky

**Postal Code:** 42051

United States

**Telephone number or internet contact information:** (270) 366-0457 / mrcool.com

**FCC Compliance Statement**

This device complies with Part 15 of the FCC Rules. Operation is subject to the following two conditions: (1) This device may not cause harmful interference, and (2) this device must accept any interference received, including interference that may cause undesired operation.



**MRCOOL**®  
COMFORT MADE SIMPLE

# **Versa Pro Wired Thermostat**

The design and specifications of this product and/or manual are subject to change without prior notice.  
Consult with the sales agency or manufacturer for details.